

Introduction to CAD

- 정의
- 역사
- 종류
- 상용 소프트웨어
- 선정 기준
- 파일 포맷
- 플랫폼: GrabCAD

CAD

- Computer Aided Design, 컴퓨터지원설계
- 컴퓨터를 이용하여 설계하는 것
- 수작업으로 수행하던 설계작업을 컴퓨터에 의한 지원으로 효율을 높이기 위함
- 컴퓨터에 의한 설계지원 도구 (CAD시스템)
- 컴퓨터를 이용한 제도시스템?
 - Computer assisted drafting, computer assisted drawing

Evolution of Computer-Aided Design (1)

- development of descriptive geometry in the 16th and 17th centuries
- creation of engineering drawings changed very little until after World War II
- 1950s, development of real-time computing, particularly at MIT
- The Fathers of CAD
 - largely credited with setting the stage for what we know today as CAD
 - Patrick Hanratty: “the Father of CADD/CAM”
 - 1957, GE, PRONTO (Program for Numerical Tooling Operations): first commercial CNC programming system
 - Ivan Sutherland
 - 1962, Ph.D. thesis at MIT “Sketchpad, A Man-Machine Graphical Communication System”: first graphical user interface

<http://www.deskeng.com/articles/aaazer.htm> (Dec 1, 2010)

Evolution of Computer-Aided Design (2)

- 1960s
 - first digitizer (from Auto-trol)
 - DAC-1: first production interactive graphics manufacturing system
 - Commercialization: SDRC, Evans & Sutherland, Applicon, Computervision, M&S Computing
- 1970s: 2D → 3D
 - Ken Versprille: invention of NURBS for his Ph.D. thesis, basis of modern 3D curve and surface modeling
 - Alan Grayer, Charles Lang, and Ian Braid: PADL (Part and Assembly Description Language) solid modeler
- Early '80s
 - emergence of UNIX workstations: commercial CAD systems like CATIA showing up in aerospace, automotive, and other industries
 - introduction of the first IBM PC in 1981: Autodesk/AutoCAD(1983), first significant CAD program for the IBM PC

Evolution of Computer-Aided Design (3)

- The CAD Revolution
 - AutoCAD: deliver 80% of the functionality of the other CAD programs of the day, for 20% of their cost (still largely 2D)
 - 1987, Pro/ENGINEER, CAD program based on solid geometry and feature-based parametric techniques for defining parts and assemblies
 - 3D modeling kernels, most notably ACIS and Parasolids
 - basis for other history-based parametric CAD programs
 - 1995, SolidWorks → Solid Edge, Inventor, and others
 - first significant solid modeler for Windows
 - many of the original CAD developers from the 1960s acquired by newer companies and a consolidation of the industry into four main players
 - Autodesk, Dassault Systèmes (which acquired SolidWorks in 1997), PTC, and UGS (now Siemens PLM)

Evolution of Computer-Aided Design (4)

- CAD Today, CAD Tomorrow
 - improvements in modeling, incorporation of analysis, and management of the products we create, from conception and engineering to manufacturing, sales, and maintenance (PLM, product lifecycle management)
 - “Engineers and designers are being asked to create more, faster, and with higher quality”
 - (Siemens PLM) combines the precision and control of feature-based design with the speed and flexibility of explicit modeling
 - (PTC) ease-of-use, interoperability, and assembly management problems with CAD
 - (Autodesk) new, very friendly, very interactive interfaces, embedded simulation, and the cloud



The Calma Digitizer workstation, introduced in 1965, allowed coordinate data to be entered and turned into computer-readable data.

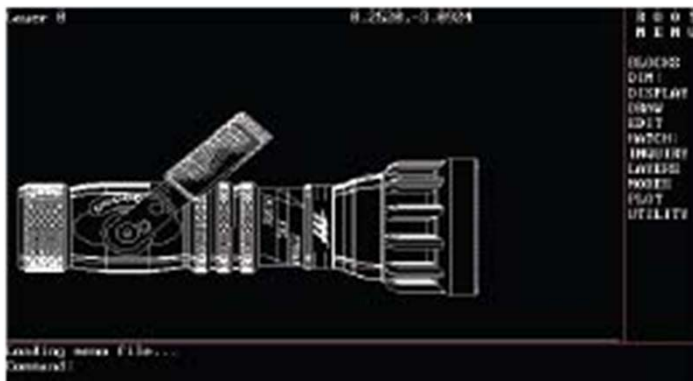
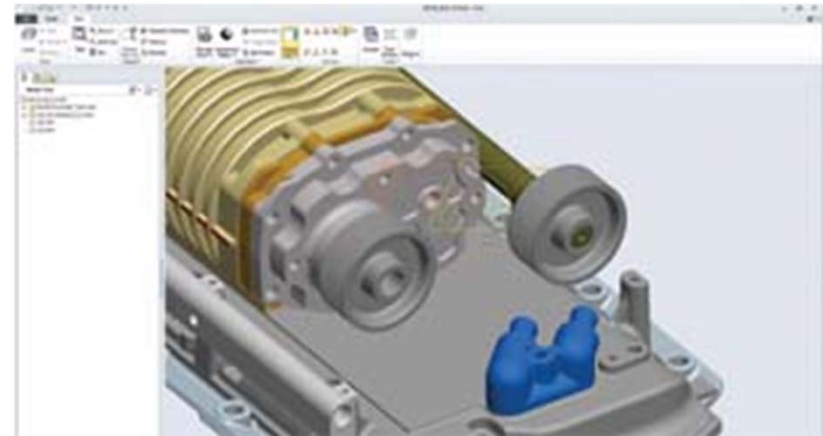

The famous AutoCAD sample nozzle drawing was created by Don Strimbu with AutoCAD 2.18.

PTC Creo, the company's new product line scheduled for 2011, will deliver task-specific applets (2D design, 3D parametric design, rendering, analysis, and more), an approach that's closer to Apple iPad and iPhone applications than to traditional CAD.

CAD in Automotive

- 1950s / General Motors
 - using Graphic Display System
 - DAC-1 for prototype of a CAD system
 - INCA for NC processing for Master Model
 - CADANCE(70s), CGS(80s) + commercial soft
- 1970s and 80s / in-house CAD System
 - Nissan / CAD-I, CAD-II & GNC / Mazda
 - Integrated CAD/CAM / Toyota
- 1990s / Commercial CAD Software

CAD in Aerospace

- 1960s and 1970s
 - CADAM / Lockheed for NC tape
 - CADD / McDonnell-Douglas
 - CATIA / Dassault
 - ICAM Project in USAF
- 1980s / Standardization
 - Network by CIIN
 - IGES(Initial Graphic Exchange Specification) Format
- 1990s / New Standardization

CAD의 종류

- 기계용 CAD (메카CAD)
- 건축용 CAD
 - BIM(Building Information Modeling)
 - 주택전용 CAD
 - 건축설비용 CAD
- 토목용 CAD
- 전기용 CAD (회로용 CAD, 기판용 CAD)

기계용 CAD (메카CAD)

- 2D CAD
- 3D CAD
- 2.5D CAD
- 업무대상, 형상요소 형태, 가격대에 따라서
 - High end: 자동차·항공기 등 의장성이 요구되는 설계
 - Middle range: 가전제품, 일반OA제품, 양산 이전에 시제품제작회수 저감 목적으로 도입

기계용 CAD (메카CAD): 사례

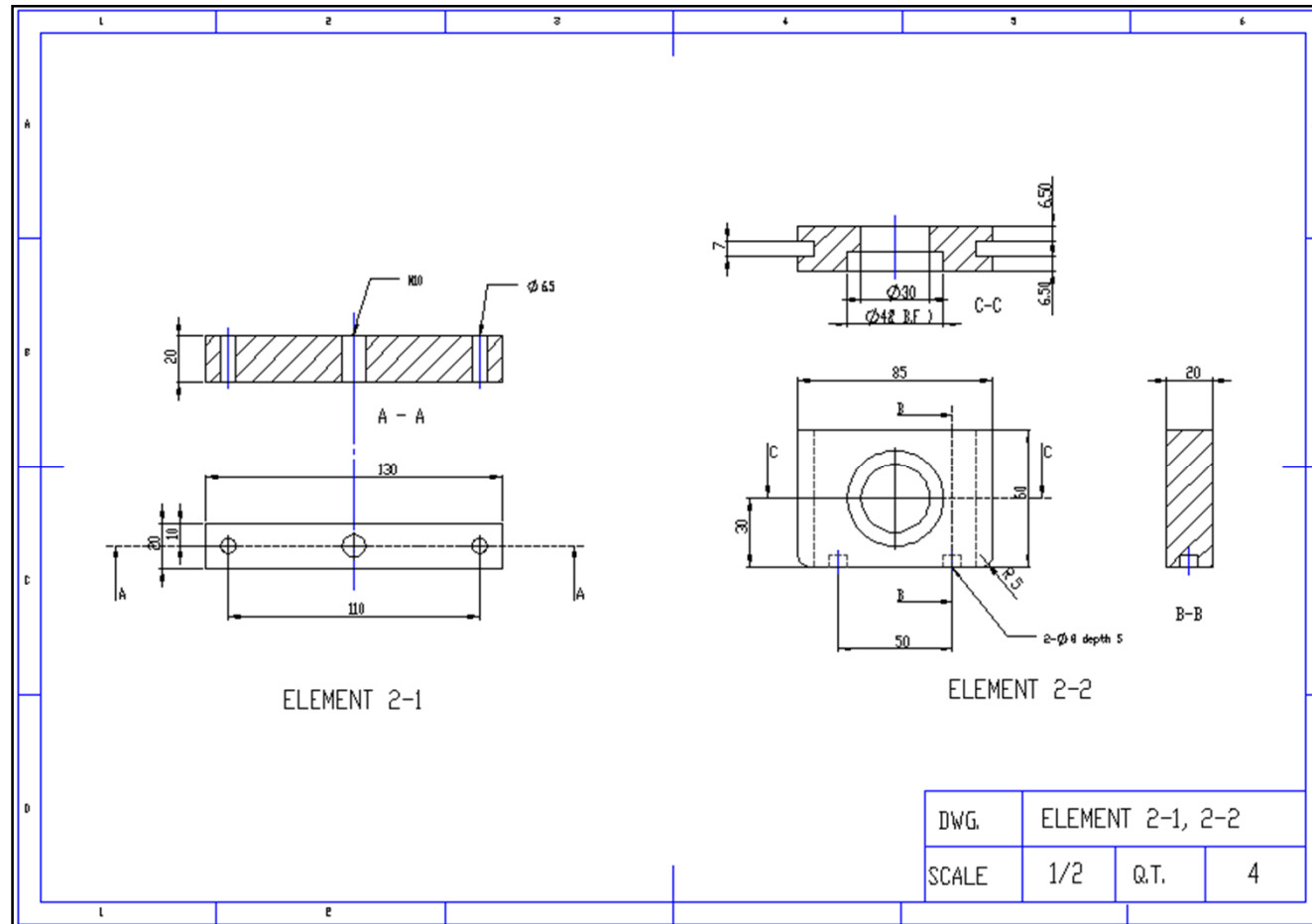

건축용 CAD

- 건축물(건물, 구조물)의 입체를 평면도, 입면도, 단면도, 투시도 등 도면으로 표현하여 시공(건축물을 제작)
- 전문영역에 따라 의장/구조/설비 등 도면 작성 S/W
- BIM
 - 3차원 모델을 건물의 설계·공정·라이프사이클 전반에 활용
 - 중립파일포맷: IFC(Industry Foundation Classes)
 - 의장·구조·설비·적산·시공·유지관리 데이터를 포괄
 - 건설업계의 S/W간의 데이터 공유와 상호 운영이 가능
 - Architecture (Bentley), Revit (Autodesk), ArchiCAD (Graphisoft)
- 건축설비용 CAD
 - 공조·급배수(위생), 전기설비의 시공도, 설계도

건축용 CAD: 사례

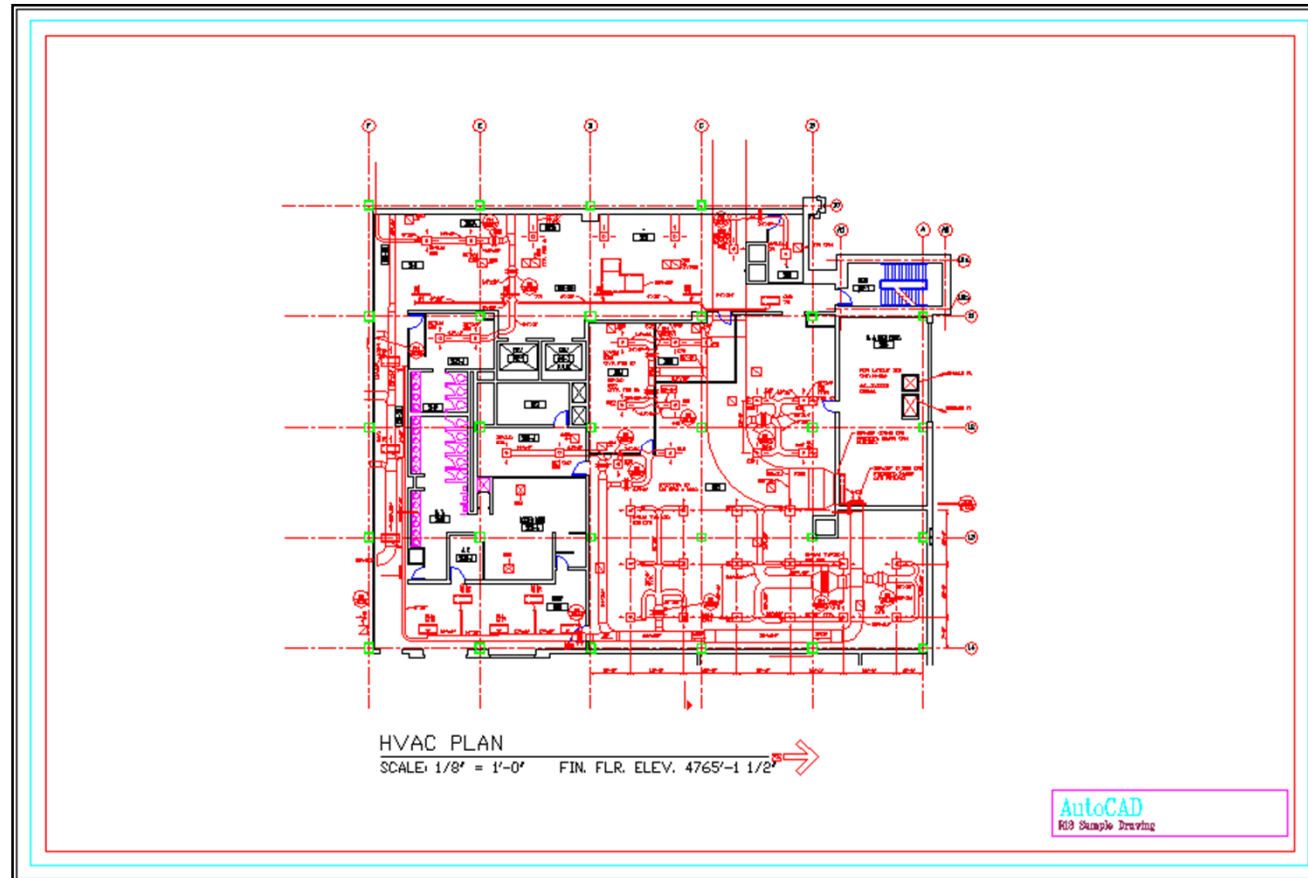

전기계 CAD

- 전자기기, 반도체 등 전기계의 설계작업을 자동화
- 기본적으로 2차원, 회로도/레이아웃(프린트기판/포토 마스크)
- 회로도: 전기, 전자회로, 논리회로 등 접속정보를 표현, 치수는 중요하지 않음→CAD?
- 레이아웃: 기판이나 여러 종류의 배선 등을 표현하기 위한 레이어(층), 블록을 이용한 계층 설계가능
- EDA (Electronic Design Automation)

전기계 CAD: 사례

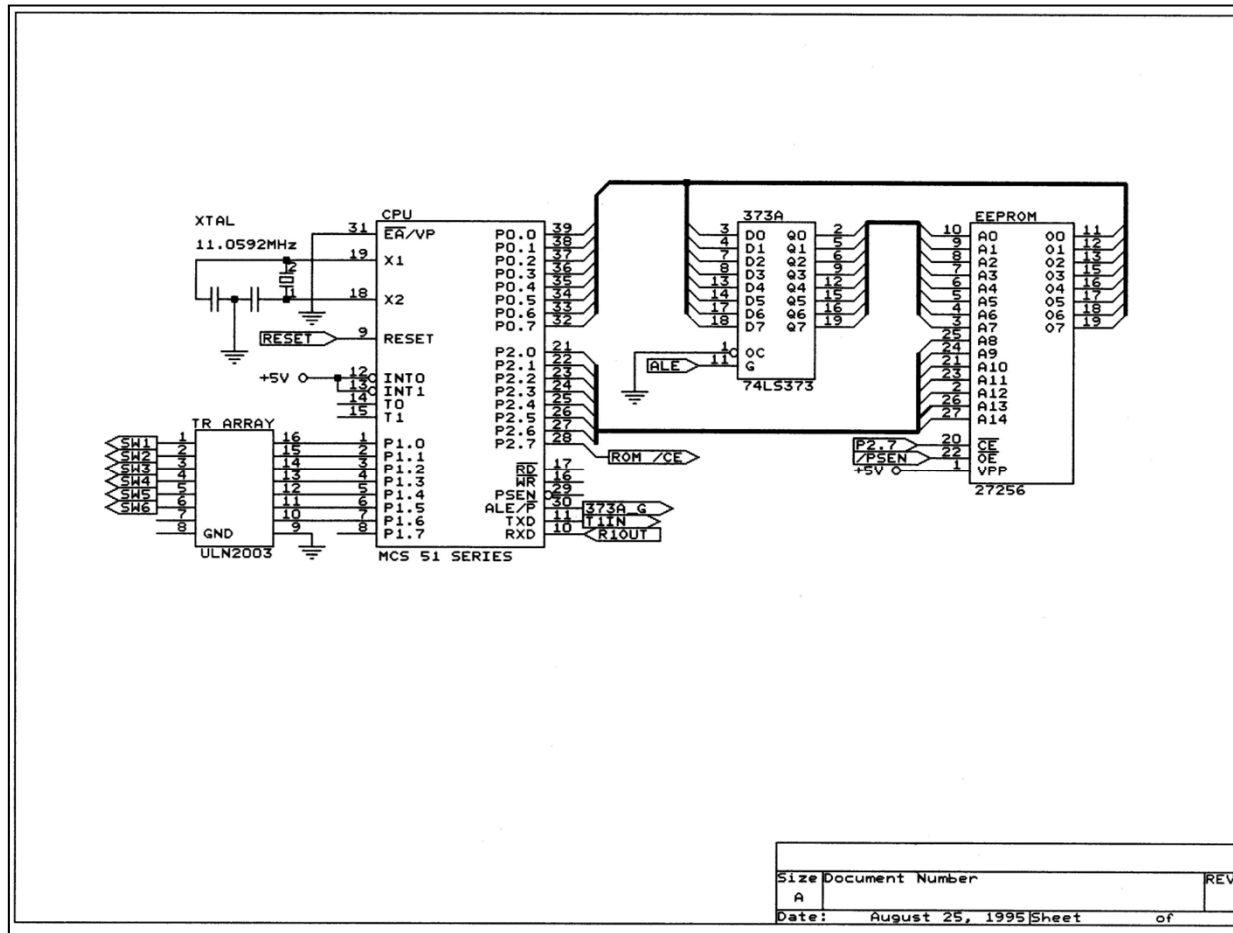

Size	Document Number	REV
A		
Date:	August 25, 1995	Sheet of

CAD Software Revenue

CAD Software Revenue

Worldwide, in millions of U.S. \$

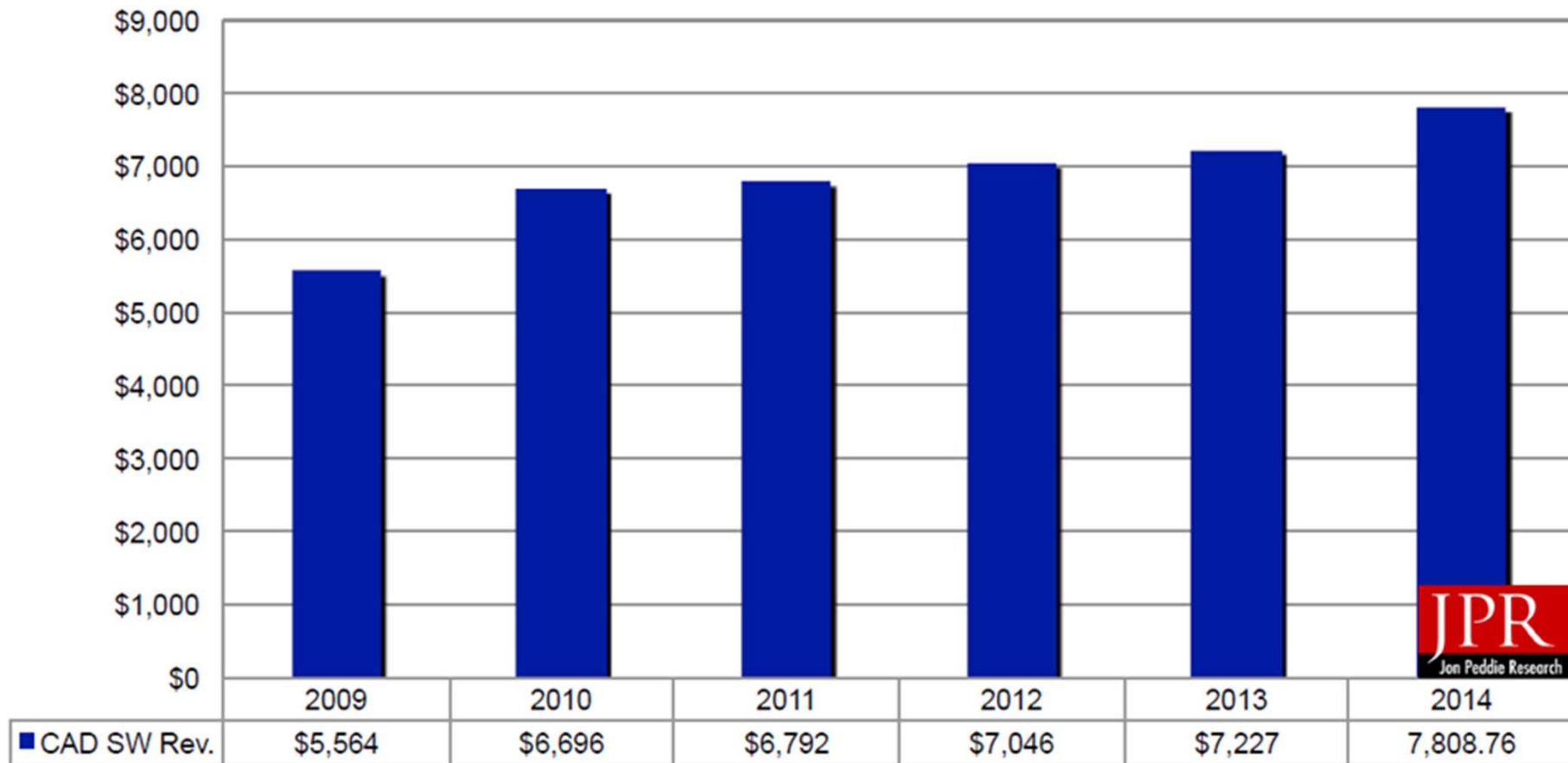

CAD Company Market Share (2011→2014)

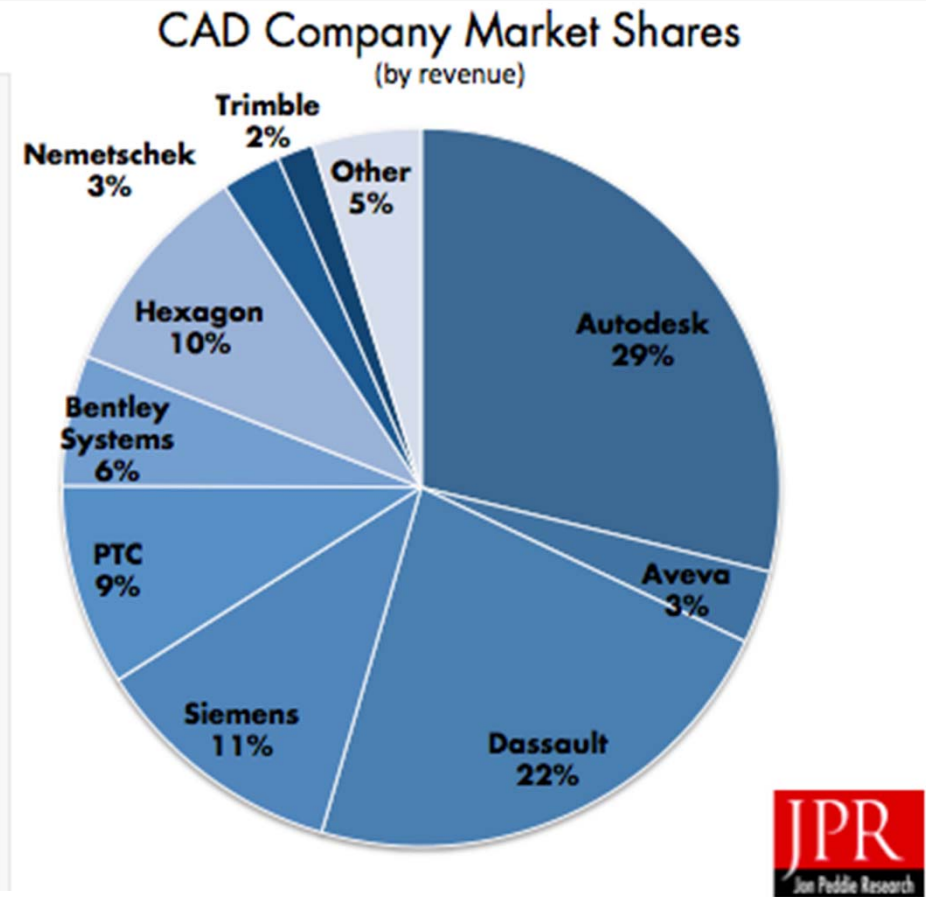
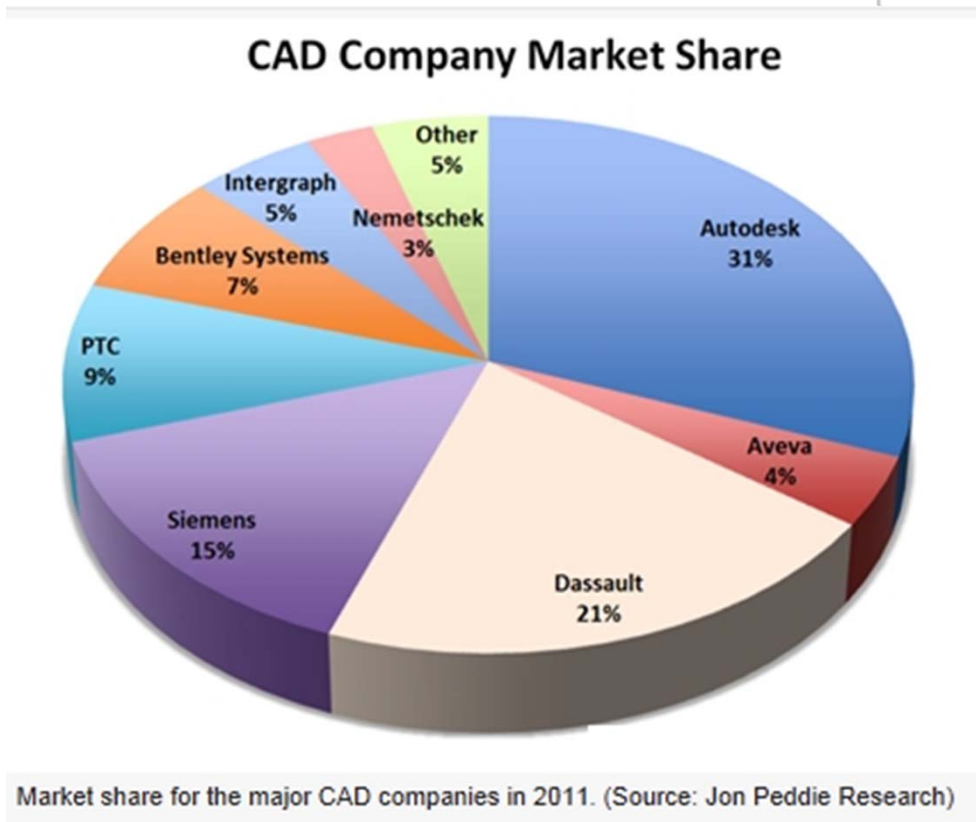

Trend: cloud computing, mobile devices, and virtualization

Automotive OEM

SIEMENS

24 of the top 25 Automotive OEM's use PLM solutions from Siemens (top 16 shown below)

Top 16 Global Manufacturers	Enterprise Collaboration			Siemens Presence
	Engineering	Collaboration	Manufacturing	
Toyota	Catia / Pro-E	in-house	Delmia/TECNOMATIX	<ul style="list-style-type: none"> • 4 of top 25 use all Siemens • 11 use NX as their core Body design tool • 9 use NX as their core Powertrain design tool • 13 use Teamcenter as their core PDM • 9 use Teamcenter as their DM backbone • 8 use Tecnomatix as their standard for DM applications
GM	NX	TEAMCENTER	TECNOMATIX	
Ford	Catia	TEAMCENTER	TECNOMATIX	
VW/Audi	Catia / Pro-E	TEAMCENTER	TECNOMATIX	
Hyundai	Catia / Pro-E	open/Teamcenter	Delmia/TECNOMATIX	
Honda	Catia	in-house/Enovia/Teamcenter	Delmia/TECNOMATIX	
Nissan	NX	TEAMCENTER	Delmia/TECNOMATIX	
PSA	Catia	Enovia	Delmia/TECNOMATIX	
Fiat	NX	TEAMCENTER	TECNOMATIX	
Renault	Catia	Teamcenter/Enovia	TECNOMATIX	
Suzuki	NX	TEAMCENTER	TECNOMATIX	
Chrysler	NX	TEAMCENTER	Delmia/TECNOMATIX	
Daimler	Catia	TEAMCENTER	Delmia/TECNOMATIX	
BMW	Catia	open/Teamcenter	Delmia/TECNOMATIX	
Mitsubishi	Catia	open/Teamcenter	Delmia/TECNOMATIX	
Mazda	NX	TEAMCENTER	TECNOMATIX	

3차원 CAD Software

회사	소프트웨어	홈페이지
Autodesk (NASDAQ: ADSK)	Autodesk Product Design Suite	http://usa.autodesk.com/
Dassault Systèmes (Euronext: DSY)	CATIA	http://www.3ds.com/
	SolidWorks	http://www.solidworks.com/
Siemens PLM Software	NX	http://www.plm.automation.siemens.com
	Solid Edge	http://www.siemens.com/solidedge
PTC (NASDAQ: PMTC)	Creo (Pro/ENGINEER)	http://www.ptc.com
Bentley Systems	MicroStation	http://www.bentley.com
Intergraph	Process, Power & Marine	http://www.intergraph.com
Aveva (UK)	Plant/Marine/Enterprise solutions	http://www.aveva.com
Nemetscheck (DE)	Vectorworks Designer	http://www.nemetschek.com

CATIA (1)

- Dassault Aviation
 - How can we define, with the computer, the shape of airplane, which is the input to aerodynamic analysis?
 - 1977~1980, development of CATI (Computer Aided Tri-dimensional Interactive application) → CATIA, four software engineers
 - Internally keeping or new business?
 - CADAM(←Lockheed Aircraft)
 - CALMA(←McDonnell Douglas Aircraft)

CATIA (2)

- Dassault Systèmes
 - July 1981, 50/50 revenue share agreement with IBM
 - President: Francis Bernard, 20 engineers, first customer: Honda
 - Business transformation rather than 2D CAD/CAM solution
 - “a revolutionary new way to design and manufacture”
 - 1986, great success with Boeing
 - Mainframe → UNIX based workstations (late 80’s) → PCs with Windows (late 90’s)
 - 1995~, President: Bernard Charles
 - 2009, acquire the IBM sales force, 15+ acquisitions, 8000+ employees, 100,000+ customers, 1,252 m€ revenue
 - 2000, PLM (Product Life Cycle Management): DELMIA, ENOVIA, SIMULIA, SolidWorks, 3DVIA

3차원 CAD 시스템 선정 기준

- 소프트웨어 사용의 편리성
 - 설계엔지니어들에게 가장 중요한 사항
- 기존 데이터의 재활용
 - 기존의 2차원 데이터를 활용
- 기술지원 능력과 경험
 - 유지관리
- 시스템 도입 비용
- 확장성

주요 파일 포맷 (1)

- DXF (Drawing Exchange Format)
 - CAD S/W에서 작성한 도면의 파일포맷, ascii/binary
 - CAD도면의 정보교환의 기본표준
 - 2차원 및 3차원 도형을 벡터 데이터로 저장
 - AutoCAD의 상이버전 간의 데이터 호환을 목적으로 제정
 - 내부 사양이 공개되어 많은 CAD제품에서 취급
 - Header/classes/tables/blocks/entities/objects/end of file
- DWG
 - AutoCAD의 표준 화일형식, binary
- IGES (Initial Graphics Exchange Specification)
 - 이종 CAD간 데이터 교환에 사용하는 중간파일포맷
 - ANSI가 제정, 자동차산업을 중심으로 실질적 세계표준

주요 파일 포맷 (2)

- STEP (Standard for the Exchange of Product model data): ISO 10303
 - Industrial automation systems and integration – Product data representation and exchange
 - 컴퓨터가 읽을 수 있는 공업제품 데이터의 표현 및 교환 규격
 - 특정 시스템에 의존하지 않는 형식으로 제품에 관한 모든 데이터를 기술하는 방법을 제공할 목적
 - CAD/CAM/CAE/PDM/EDM 등의 시스템에서 데이터 교환에 사용: 기계설계/전자설계/분석/제조 데이터
 - ISO 기술위원회 TC 184 (Technical Industrial automation systems and integration)의 분과회 SC4(Industrial data)에서 제정, 보수

주요 파일 포맷 (3)

구분	이름	파일형식
중립파일 포맷	STEP	*.stp, *.step
	IGES	*.igs, *.iges
상용모델링 커널포맷	Parasolid	*.x_t,*.xmt_txt, *.x_b, *.xmt_bin
	ACIS	*.sat, *.sab, *.asat, *.asab
상용 3D CAD 제품	CATIA V5	*.CATPart, *.CATProduct, *.CGR
	CATIA V4	*.model, *.exp, *.session
	UG/NX	*.prt
	Creo/Parametric	*.ptr, *.asm
	SolidWorks	*.sldprt, *.sldasm
	Solid Edge	*.x_t,*. x_b
	Inventor Part/Assembly	*.ipt, *.iam

3D 데이터 확보 방법 비교

- 3D-CAD 등 모델링 툴을 사용하는 방법
 - 장점: 자유도 높은 3D 데이터 생성이 가능
 - 단점: 3D-CAD 구입에 따른 투자 필요, 사용법 습득에 시간 소요, 형상이 복잡해질수록 작업공수 증가
- 3D 스캐너를 사용하는 방법
 - 장점: 기존 형상을 재현하기 용이, 보면서 모델링하는 것보다 정확하고 용이, 외관색 등 표면 매핑도 가능
 - 단점: 기본적으로 점 데이터로 3D 프린팅을 위해서 데이터 변환이 필요, 스캔 불가 또는 부정확한 부분에 대한 추가 작업 필요 (X선CT)
- 데이터 공유 사이트를 이용하는 방법
 - 장점: 쉽고 빨리 3D 데이터 입수, 모델링 툴이나 3D 스캐너 구입이나 사용법 숙련도 불필요
 - 단점: 지적재산권 보호, 책임소재

GrabCAD

- 2009년 에스토니아 기계설계엔지니어 2인이 미국에서 설립
 - 3D 데이터 형식이나 3D-CAD 등 틀에 신경쓰지 않고 다수가 자유롭게 사용할 수 있는 설계환경의 필요성
- 2014년 Stratasys사가 인수
- 세계 최대 3D 데이터 공유사이트
- 사용자 등록하면 누구나 무료로 다운로드, 업로드
- 사용자수 215만명, 파일 등록 82만개 이상(2015년 5월 기준)
- 공유뿐 아니라 다수가 협업하는 open innovation 기반
 - GrabCAD Print: 3D 프린팅 지원
 - GrabCAD Workbench: 다수 유저에 의한 공동 프로젝트를 지원
 - GrabCAD Community: 파일공유와 커뮤니케이션 기능 제공
 - Library: free CAD files
 - Challenge: 디자인이나 설계 아이디어를 전세계 기술자로부터 공모
 - Tutorials

https://grabcad.com

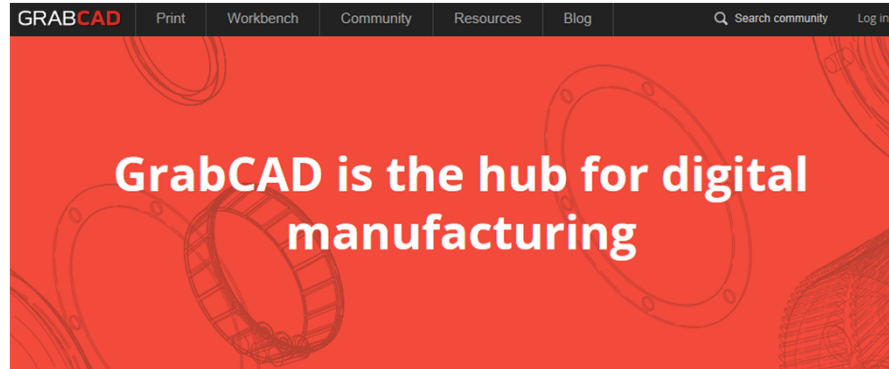

“*GrabCAD Workbench helps us speed up our iteration cycle to produce the best product for our customers. We're able to quickly point out changes, leave a comment for team members, and then add revisions and track the latest version. An efficient design process means better germ zappers and a healthier company.*”

XENEX  **Deepak Jayaraj**
Mechanical Engineer

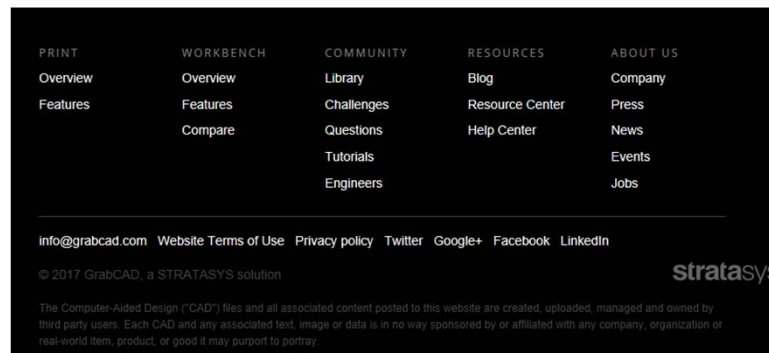

GrabCAD Workbench

GrabCAD Workbench

The free and easy way to manage and share your CAD files.

Workbench is a CAD collaboration solution that accelerates product development by making it easy for engineers to manage files and engage partners in the design process.

[Sign up for Workbench](#)

[See Workbench overview](#)

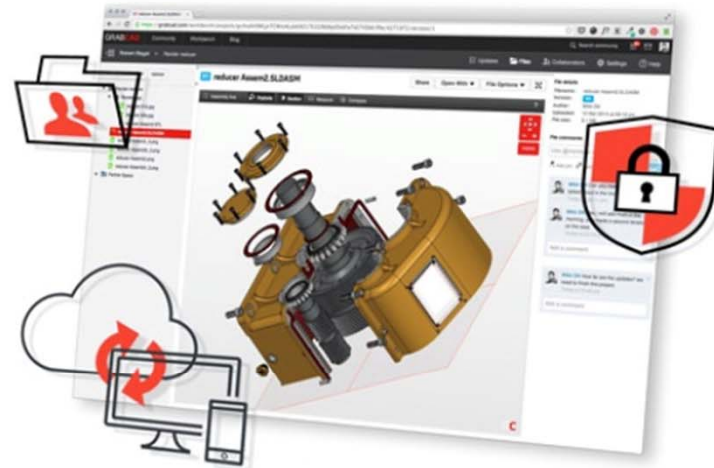

USED BY THOUSANDS OF COMPANIES



웹 브라우저를 사용하여 다양한 3D 데이터를 공유 가능
구성트리를 보거나 단면형상을 보는 것도 가능
클라우드 상에 협업을 위한 프로젝트 생성 가능(주최자)
참가멤버 초대, 정보열람/수정/코멘트추가

GrabCAD Community

GrabCAD Workbench 사용자 증가
→ 프로젝트를 넘어 협업으로 발전

카테고리로 3D 데이터 검색(Library)
→ 키워드 이외에 3D-CAD 명칭과 버전,
업종 등
→ 결과: 등록시기, 다운로드 수, 코멘트
수 등으로 분류가능

규격품 설계: 작업효율화, 시간단축
→ 검색, 다운로드, 수정(코멘트), 업로드

S/W뿐만 아니라 H/W분야에서도 오픈소
스개발 사례 등장
→ 3D 프린터의 보급

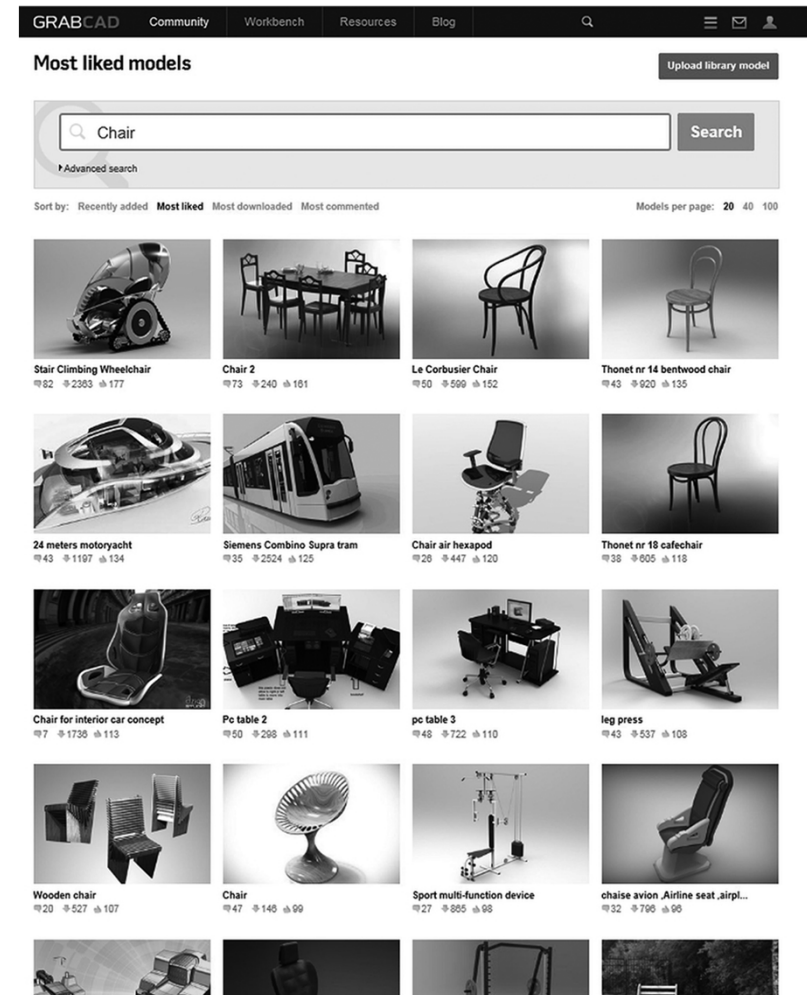

"chair"란 키워드로 검색한 결과로 3D 데이터에
연결된 다양한 정보가 포함되어 있음

GrabCAD Challenge (GE 사례)

Jet Engine의 bracket 설계안 공모 (화면은 하중조건)

하중조건
부착부 형상
재질
사용환경온도
3D 프린터

1차 심사: 2013.06.12~08.09
→ 10명, 각 USD1,000
→ 총 USD 10,000
2차 심사: 2013.09.17~11.15
→ 1등 USD7,000 2등 USD5,000
→ 총 USD 20,000

GRABCAD Community Workbench Resources Blog Log in

New engineering challenges every week
Use your skills and earn money with your work

Take part and earn money

GE jet engine bracket challenge

Description Entries 640 Results

Jet engine bracket challenge.

GRABCAD

All aircraft engines require manufacturing creates like structures. Here is

When designing critical components between performance requirements. Recently, software tools have been manufacturing methods restrict level of complexity. Additive manufacturing is lifting the constraints of traditional manufacturing processes, giving designers the ability to grow practically any shape, enabling the use of fully optimized lightweight designs that do not sacrifice performance.

Participants in this challenge will use additive manufacturing as the basis for optimizing an existing aircraft engine bracket.

The designs submitted will be analyzed and evaluated via simulation, and the top ten designs will be selected for fabrication and testing. These optimized engine bracket designs will be additively manufactured and subjected to a given loading scenario. The winning entries will best satisfy all of the performance criteria with the lowest mass.

The part

Load Conditions 1
Static
Vertical
8000 lbs up

Load Conditions 2
Static
Horizontal
8500 lbs out

Load Condition 3
Static
42 degrees from Vertical.
9500 lbs out

Load Condition 4
Static Torsional
Horizontal plane at centerline of clevis.
5000 lb-in

Load Interfaces
Interface 1
Interface 2
Interface 3
Interface 4
Interface 5

Dr. William Carter
Mechanical Engineer, Additive Manufacturing Laboratory, GE Research

Have an awesome idea for this competition? Want to win cool prizes? Sign-up now to upload your entries.

GrabCAD Challenge (GE사 공모결과)

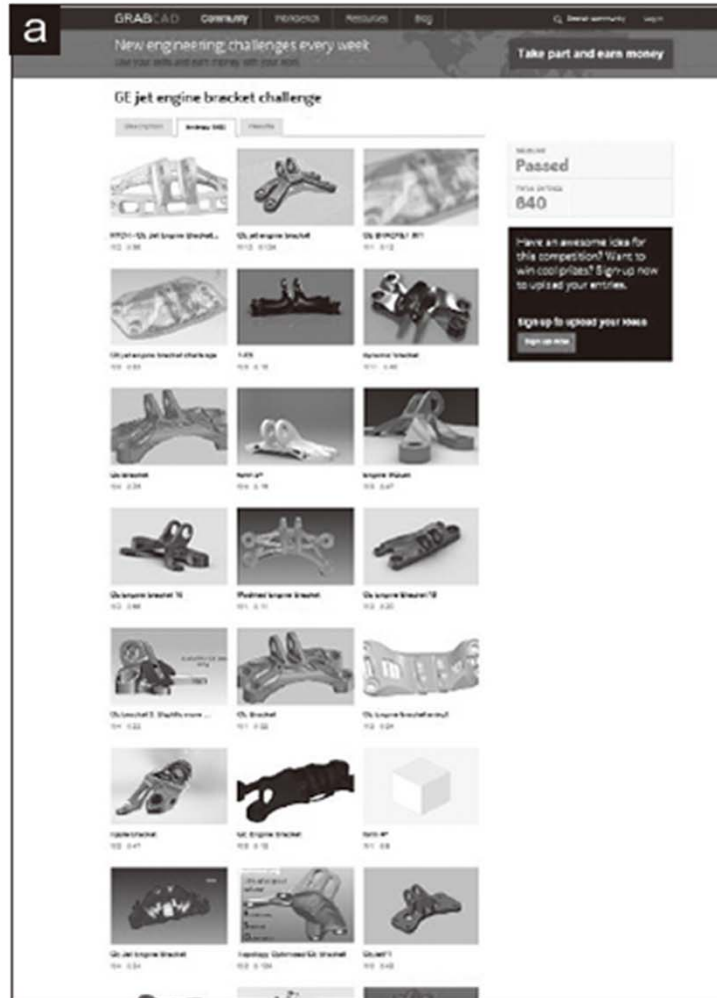

2033g → 327g

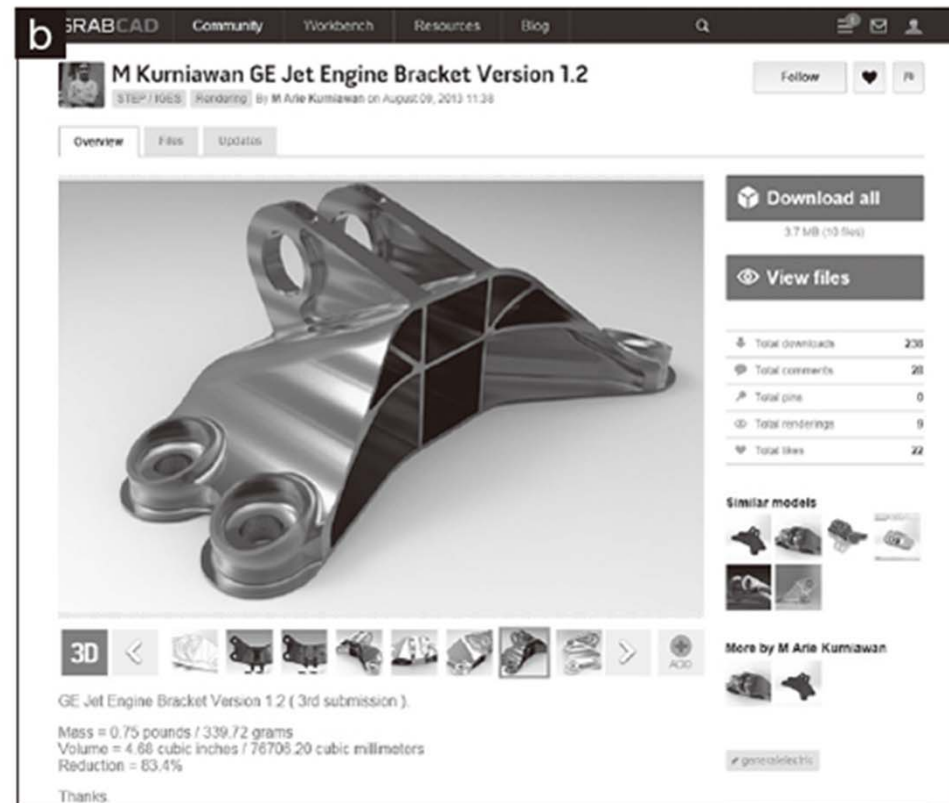

(a) 1차 심사: 640 설계안 제출 (b) 우승(84%나 경량화), 인도네시아 엔지니어

설계의 종류

- 노하우를 통해 보안이 요구되는 설계
 - 기존대로 사내에서 실시
- 규격품 등 동일한 품질이 가능한 설계
 - GrabCAD Community에서 검색
- 새로운 아이디어나 획기적인 신규설계
 - GrabCAD Challenge를 활용, 꼼꼼히 분류하여 대응하는 것이 중요